

# KENWOOD

STEREO CASSETTE TAPE DECK

**CT-405**

**KXF-W4030**

---

**INSTRUCTION MANUAL**

KENWOOD CORPORATION

## Before applying power

**⚠ Caution: Read this section carefully to ensure safe operation.**

Units are designed for operation as follows.

U.S.A. and Canada .....	AC 120 V only
Australia .....	AC 240 V only
Europe and U.K. ....	AC 230 V only
*Other countries	AC 110-120 / 220-240 V switchable



As an ENERGY STAR® Partner, Kenwood Corporation has determined that this products meets the ENERGY STAR® guidelines for energy efficiency.

This product can save energy. Saving energy reduces air pollution and lowers utility bills.

### For the United Kingdom

#### Factory fitted moulded mains plug

1. The mains plug contains a fuse. For replacement, use only a 13-Amp ASTA-approved (BS1362) fuse.
2. The fuse cover must be refitted when replacing the fuse in the moulded plug.
3. Do not cut off the mains plug from this equipment. If the plug fitted is not suitable for the power points in your home or the cable is too short to reach a power point, then obtain an appropriate safety approved extension lead or adapter, or consult your dealer. If nonetheless the mains plug is cut off, remove the fuse and dispose of the plug immediately, to avoid a possible shock hazard by inadvertent connection to the mains supply.

#### IMPORTANT

The wires in the mains lead are coloured in accordance with the following code:

Blue : Neutral  
Brown : Live

Do not connect those leads to the earth terminal of a three-pin plug.

### \*AC voltage selection

The AC voltage selector switch on the rear panel is set to the voltage that prevails in the area to which the unit is shipped. Before connecting the power cord to your AC outlet, make sure that the setting position of this switch matches your line voltage. If not, it must be set to your voltage in accordance with the following direction.

#### AC voltage selector switch



Move switch lever to match your line voltage with a small screwdriver or other pointed tool.





#### Note:

Our warranty does not cover damage caused by excessive line voltage due to improper setting of the AC voltage selector switch.

## Safety precautions

**⚠ Caution: Read this section carefully to ensure safe operation.**

**WARNING: TO PREVENT FIRE OR ELECTRIC SHOCK, DO NOT EXPOSE THIS APPLIANCE TO RAIN OR MOISTURE.**

 <div data-bbox="249 1690 461 1753" style="border: 1px solid black; padding: 2px; text-align: center;"> <b>CAUTION</b>  <small>RISK OF ELECTRIC SHOCK DO NOT OPEN</small> </div> 	<p>CAUTION: TO REDUCE THE RISK OF ELECTRIC SHOCK, DO NOT REMOVE COVER (OR BACK). NO USER-SERVICEABLE PARTS INSIDE. REFER SERVICING TO QUALIFIED SERVICE PERSONNEL.</p>
	<p>THE LIGHTNING FLASH WITH ARROWHEAD SYMBOL, WITHIN AN EQUILATERAL TRIANGLE, IS INTENDED TO ALERT THE USER TO THE PRESENCE OF UNINSULATED "DANGEROUS VOL-TAGE" WITHIN THE PRODUCT'S ENCLOSURE THAT MAY BE OF SUFFICIENT MAGNITUDE TO CONSTITUTE A RISK OF ELECTRIC SHOCK TO PERSONS.</p>
	<p>THE EXCLAMATION POINT WITHIN AN EQUILATERAL TRIANGLE IS INTENDED TO ALERT THE USER TO THE PRESENCE OF IMPORTANT OPERATING AND MAINTENANCE (SERVICING) INSTRUCTIONS IN THE LITERATURE ACCOMPANYING THE APPLIANCE.</p>

## Dolby HX pro and Auto-Bias function

- The Dolby HX pro headroom extension and auto-bias function provide a recording with superior high-frequency characteristics.

## DPSS function

- Simple operations allow you to use the following convenient functions.  
① Skip Play ② Single-tune repeated playback  
(DPSS: Direct program Search System)

## CCRS function

- This function automatically sets the optimum recording level of the disc to be recorded, making it easy to record a CD.  
(CCRS: Computer-Controlled CD Recording System)

## Dubbing function

- With an easy operation, the tape loaded in deck A can be dubbed onto the tape in deck B, making it easy to record a CD.

## Unpacking

Unpack the unit carefully and make sure that all accessories are put aside so they will not be lost.

Examine the unit for any possibility of shipping damage. If your unit is damaged or fails to operate, notify your dealer immediately. If your unit was shipped to you directly, notify the shipping company without delay. Only the consignee (the person or company receiving the unit) can file a claim against the carrier for shipping damage.

We recommend that you retain the original carton and packing materials for use should you transport or ship the unit in the future.

Keep this manual handy for future reference.

## Accessories

Check that the following accessories are present.

Audio cord ..... (2)

System control cord ..... (1)





AC plug adaptor ..... (1)



Use to adapt the plug on the power cord to the shape of the wall outlet.  
(Accessory only for regions where use is necessary.)

## Contents

Caution: Read the pages marked  carefully to ensure safe operation.

Introduction .....	2
 Before applying power .....	2
 Safety precautions .....	2
Special features .....	3
Important items .....	4
Maintenance .....	4
Reference .....	4
System connections .....	6
Controls and indicators .....	8
Preparation for playback (recording) .....	10
Playback (recording) preparation .....	10
Listening to cassette tapes .....	11
Normal playback .....	11
Relay playback .....	12
Convenient music search (DPSS) .....	14
Skip play operation .....	14
Single-tune repeated playback operation .....	15

How to record (Deck B only) .....	16
Normal recording .....	16
Tape dubbing operation (Deck A → Deck B) .....	19
Tape dubbing .....	19
Convenient CD recording (Deck B only) .....	20
CD synchro recording .....	20
Recording of CD playback (CCRS)(Deck B only) .....	21
Timer operations .....	22
Timer playback of tape .....	22
Timer recording of tuner broadcast(Deck B only) .....	23
In case of difficulty .....	24
Glossary .....	26
Specifications .....	27

## Maintenance

### Cleaning

Unplug this appliance from the wall outlet before cleaning. Do not use volatile solvents such as alcohol, paint thinner, gasoline, or benzine, etc. to clean the cabinet. Use a clean dry cloth.

### Caution against contact revitalizer

Do not use contact cleaners because it could cause a malfunction. Be specially careful against contact cleaners containing oil, for they may deform the plastic components.

### Cleaning the head section

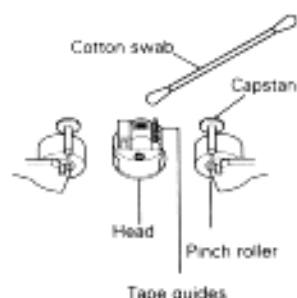

#### Cleaning the heads and peripheral components

For maintaining the best condition of the deck and for longer service life, always keep the head (recording/playback/erase), capstan and pinch roller clean. To clean them, perform the following:

1. Open the cassette holder.
2. Using a cotton swab dipped in alcohol, clean the head (recording/playback/erase), capstan and pinch roller carefully.

#### Demagnetizing the head

When the recording/playback head is magnetized, the sound quality will be deteriorated. In such a case, demagnetize the head using a commercially available demagnetizer (head eraser).



There are precisely aligned parts around the heads, including the tape guides. When cleaning, pay special attention so as not to apply shock to them.

## Reference

### Caution on condensation

Condensation (of dew) may occur inside the unit when there is a great difference in temperature between this unit and the outside.

This unit may not function properly if condensation occurs. In this case, leave the unit for a few hours with the power left ON, and restart the operation after the condensation has dried up.

#### Be specially cautions against condensation in a following circumstance:

When this unit is carried from a place to another across a large difference in temperature, when the humidity in the room where this unit is installed increases, etc.

Dolby noise reduction and HX Pro headroom extension manufactured under license from Dolby Laboratories Licensing Corporation. HX Pro originated by Bang & Olufsen. "DOLBY", the double-D symbol and "HX PRO" are trademarks of Dolby Laboratories Licensing Corporation.

### WARNING NOTICE:

**IN MOST CASES IT IS AN INFRINGEMENT OF COPYRIGHT TO MAKE COPIES OF TAPES OR DISCS WITHOUT THE PERMISSION OF THE COPYRIGHT OWNERS. ANYONE WISHING TO COPY COMMERCIALY AVAILABLE TAPES OR DISCS SHOULD CONTACT THE MECHANICAL COPYRIGHT PROTECTION SOCIETY LIMITED OR THE PERFORMING RIGHTS SOCIETY LIMITED.**

## Handling the cassette tape

### Notes on cassette tape

#### Safety tab (accidental erasure prevention tab)

After an important recording has been finished, break the safety tab, to prevent the recorded contents from being erased or recorded on accidentally.

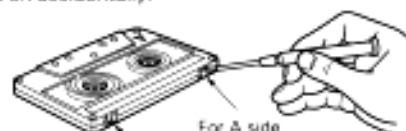

For B side

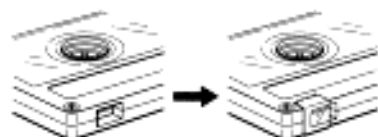

#### To re-record

Apply tape only to the position where the tab has been removed.

### To store cassette tapes

Do not store the tapes in a place which is subject to direct sunlight, or near equipment that generates heat. Keep the cassette tapes away from any magnetic field.



### When there is slack in the tape

In such a case, insert a pencil into the reel hole and wind the reel hub to remove the slack.

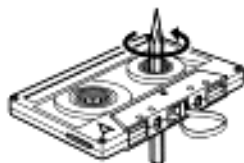

#### 1. Longer tape than 110 minutes cassette tape

Since longer tape than 110 minutes cassette tape is very thin, the tape could adhere to the pinch roller or be easily cut. It is recommended that these tapes not be used with this unit to prevent possible damage.

#### 2. Endless tapes

Do not use an endless tape, as this could damage the mechanism of the unit.



## For CANADA

### Canadian IC Compliance Notice

NOTICE: This Class B digital apparatus meets all requirements of the Canadian interference-Causig Equipment Regulations.

## For the U.S.A.

### FCC WARNING

This equipment may generate or use radio frequency energy. Changes or modifications to this equipment may cause harmful interference unless the modifications are expressly approved in the instruction manual. The user could lose the authority to operate this equipment if an unauthorized change or modification is made.

#### NOTE:

This equipment has been tested and found to comply with the limits for a Class B digital device, pursuant to Part 15 of the FCC Rules. These limits are designed to provide reasonable protection against harmful interference in a residential installation. This equipment may cause harmful interference to radio communications, if it is not installed and used in accordance with the instructions. However, there is no guarantee that interference will not occur in a particular installation. If this equipment does cause harmful interference to radio or television reception, which can be determined by turning the equipment off and on, the user is encouraged to try to correct the interference by one or more of the following measures:

- Reorient or relocate the receiving antenna.
- Increase the separation between the equipment and receiver.
- Connect the equipment into an outlet on a circuit different from that to which the receiver is connected.
- Consult the dealer or an experienced radio/TV technician for help.

# System connections

Make connections as shown below.  
When connecting the related system components, refer also to the instruction manuals of the related components.

## Caution:

Do not plug in the power lead until all connections are completed.

## Malfunction of microcomputer



If operation is not possible or erroneous display appears even though all connections have been made properly, reset the microcomputer referring to "In case of difficulty". → 24

( Except for U.S.A., Canada )

## Caution

Be sure to adhere followings. Or proper ventilation will be blocked causing damage or fire hazard

- Do not place any objects impairing heat radiation onto the top of unit.
- Leave a space around the unit (from the largest outside dimension including projection) equal or greater than, shown below.

Top panel : 50 cm      Side panel : 10 cm      Back panel : 10 cm

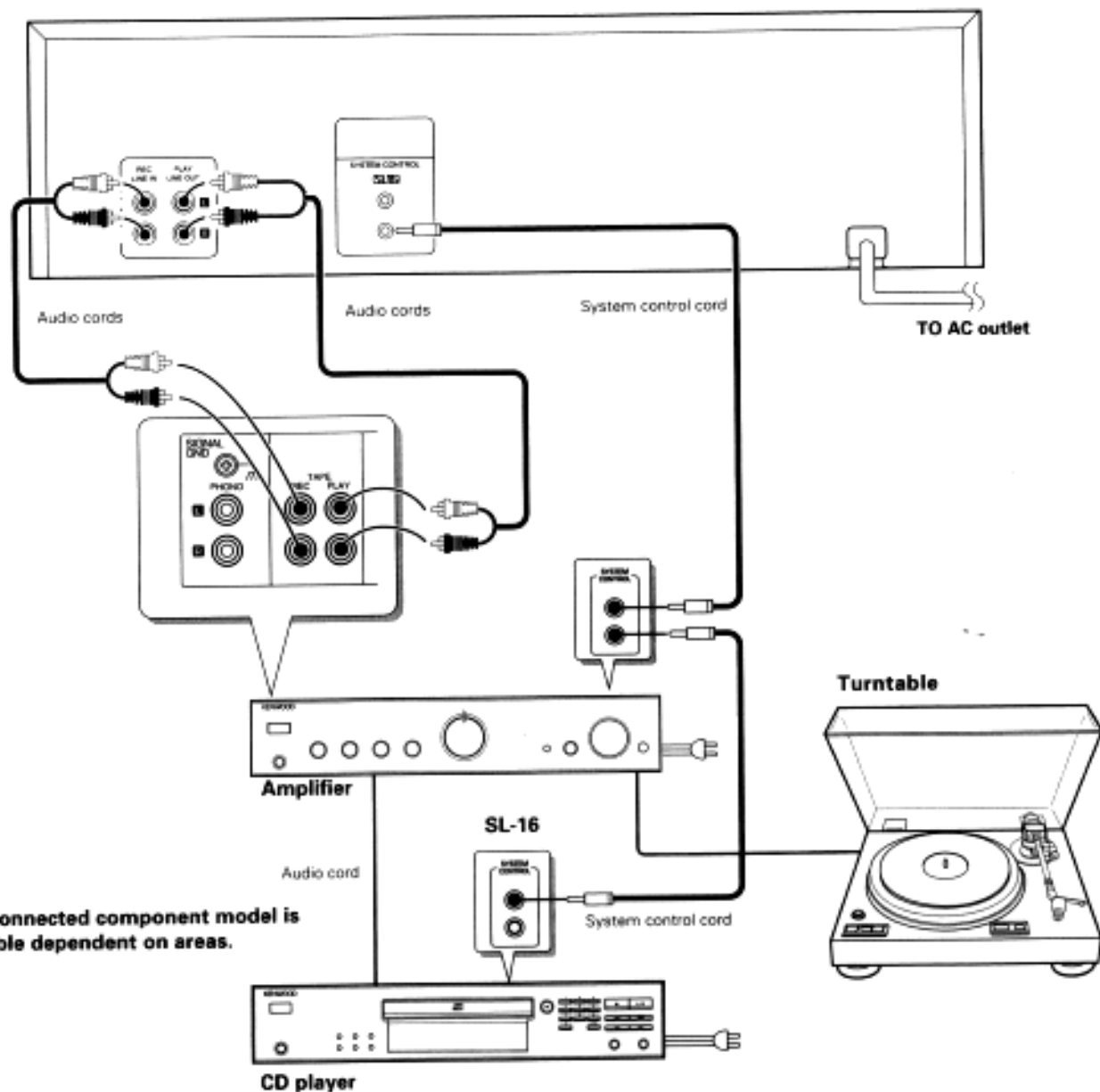

\*The connected component model is variable dependent on areas.



1. Connect all cords firmly. If connections are loose, there could be loss of sound or noise produced.
2. When plugging and unplugging connection cords, be sure to first remove the power cord from the AC outlet. Plugging/unplugging connection cords without removal of the power cord can cause malfunctions or damage to the unit.

## SYSTEM CONTROL CONNECTIONS

Connecting system control cords after connecting a KENWOOD audio component system lets you take advantage of convenient system control operations.

This unit is compatible only with the [SL16] mode. The system control operation is not available if the unit is connected in the [XS-8] connection mode.

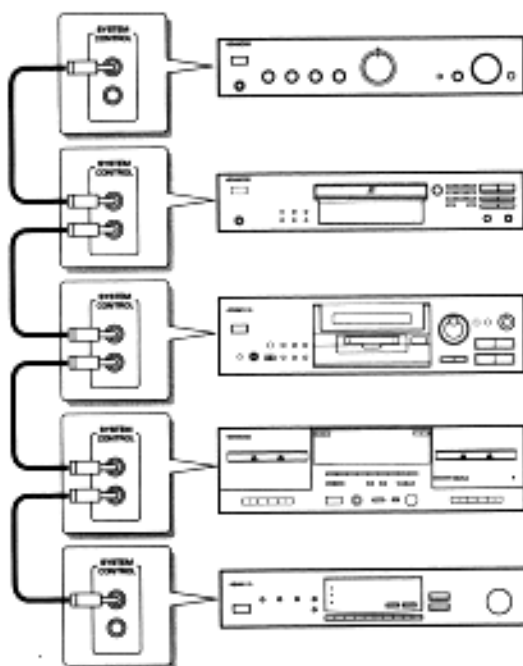

- Do this operation after completing all connections. (Ensure that the unit is set to POWER OFF.)



1. If your amplifier or receiver does not have a system control terminal, do not connect any system control cords to the system control terminals on the other components.
2. Do not connect system control cords to any components other than those specified by Kenwood. It may cause a malfunction and damage your equipment.
3. Be sure the system control plugs are inserted all the way in to the system control terminals.

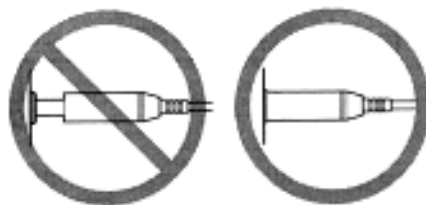

## SYSTEM CONTROL OPERATIONS

### Remote Control

Lets you operate this unit with the system remote control unit supplied with the amplifier or receiver.

### Automatic Operation

Automatically switches the input selector on the amplifier or receiver when you start playback from this unit.

### Synchronized Recording

Lets you synchronize recording with the start of playback when recording from CD.

# Controls and indicators

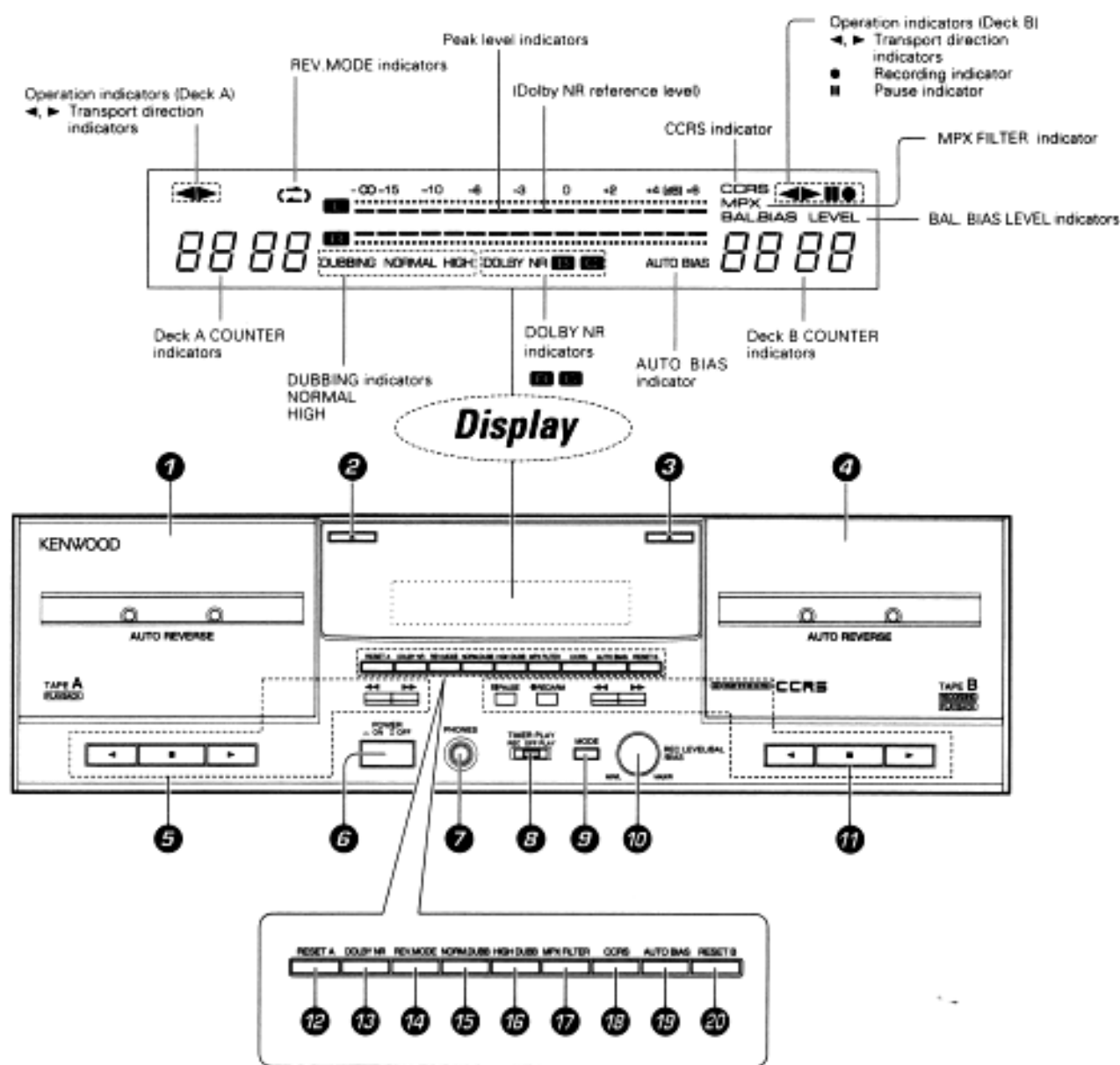



- 1 Deck A**  
This deck is used exclusively for playback.
- 2 Deck A eject (▲) key** - 19  
Press to open the cassette holder of deck A.
- 3 Deck B eject (▲) key** - 19  
Press to open the cassette holder of deck B.
- 4 Deck B**  
This deck is capable of both playback and recording.
- 5 Deck A operation keys** - 19 -- 11  
◀◀ : Rewind key (for fast winding of tape toward the left reel seen from you)  
▶▶ : Fast Forward key (for fast winding of tape toward the right reel seen from you)  
◀, ▶ : Play keys  
■ : Stop key (Stop)
- 6 POWER switch** - 19  
Press to turn this unit **ON** and **OFF**.
- 7 PHONES jack** - 11  
Connect stereo headphones (optional) here.
- 8 TIMER switch** - 22  
This switch is used in setting of timer playback and timer recording.
- 9 MODE key** - 19  
Press to change the recording level, balance, or bias settings.
- 10 REC LEVEL/BAL/BIAS knob** - 19  
Adjust this before recording.
- 11 Deck B operation keys**  
◀, ▶ : Play keys  
■ : Stop key (Stop)  
◀◀ : Rewind key (for fast winding of tape toward the left reel seen from you)  
▶▶ : Fast Forward key (for fast winding of tape toward the right reel seen from you)  
**pause (⏸) key** - 11  
: Press to let tape transport pause temporarily.  
**record (●REC/ARM) key** - 18  
: Press in stop mode to start recording or press in record mode to let the recording pause after leaving a non-recorded blank of 4 seconds.
- 12 RESET A key** - 11  
Press to reset the tape counter of deck A to "0000".
- 13 DOLBY NR key** - 10  
Press to switch the Dolby Noise Reduction mode to **B** → **C** → **OFF**. This makes it possible to use the Dolby NR effect in recording and playback.
- 14 REV. MODE key** - 19  
Press to change the tape transport direction.
- 15 NORM.DUBB. key** - 18  
Dubbing at the normal speed.
- 16 HIGH DUBB. key** - 19  
Dubbing at a high speed.
- 17 MPX FILTER key** - 21  
Press to reduce beat noise when recording FM broadcasts.
- 18 CCRS key** - 21  
Press to start recording after automatic setting of the optimum CD recording level and optimum tape recording bias.
- 19 AUTO BIAS key** - 18  
When this key is pressed, the bias level appropriate for the tape is set automatically for recording.
- 20 RESET B key**  
Press to reset the tape counter of deck B to "0000".

# Preparation for playback (recording)

## Before playback (recording)

- ① Set the **TIMER** switch to **OFF**.



- ② Set the **POWER** switch to **ON**.



 : Keys and control used in the operations described on this page.

## Playback (recording) preparation

### 1 Load a cassette tape in deck A or B.

- ① Press the **eject** () key.



- ② Insert a tape and close the cassette holder.

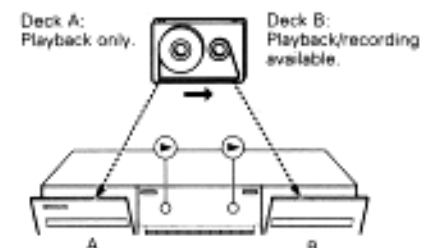

- Be sure to remove tape slack before insertion.
- The type of tape, that is, the Normal, High position or Metal position (playback only) is selected automatically.
- This unit cannot record sound on a Metal tape.
- Be sure to close the cassette holder securely by pushing it.

Normal position	TYPE I
High position	TYPE II
Metal position (playback only)	TYPE IV

### 2 Select the tape transport direction.

- ① Press the **play** ( or ) key.



To play (record) tape side B.



To play (record) tape side A.

Feed the tape section which cannot be played or recorded onto in the forward direction.

- ② Press the **stop** () key.



### Tape transport direction indicators

The  and  indicators show the direction the tape is transported during recording or playback. The direction used when the tape is last stopped is held in memory even after this unit has been turned OFF, and the tape transport starts in the indicated direction when the unit is started automatically by a timer, etc. To change the tape transport direction, press the play key for the opposite direction and immediately press the stop  key.

Deck A direction indicators.

Deck B direction indicators.

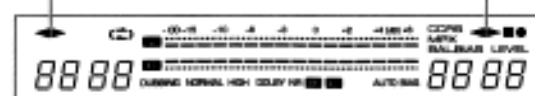

### 3 Determine the playback (recording) condition.



- ① Select the **playback (recording) mode**.



- ② Select the **Dolby NR mode**.



Each press switches the indication.

- ①  : **Double-side playback (recording)** which stops tape stops after having played (or recorded) both sides.
- ②  : **Playback is endless**, but recording stops after having recorded both sides.
- ③  : **One-way playback (recording)** which stops tape after having played (or recorded) a single side.

Each press switches the indication.

- ① **DOLBY NR "OFF"** (extinguished): Dolby NR is not used.
- ② **DOLBY NR "B"**: Noise reduction of the ordinary type.
- ③ **DOLBY NR "C"**: Noise reduction with higher performance.

• Select the Dolby NR mode according to the tape recording status.

# Listening to cassette tapes

## Preparation

Make "Playback (recording) preparation".



## To use the headphones

Connect commercially-available stereo headphones to the **PHONES** jack for private listening.



## Normal playback

### Start playback

Press the play (◀ or ▶) key.

To play side B.

To play side A.

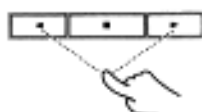

- Tapes are played in the directions indicated by their respective indicators on the display.

### Fast forwarding or rewinding tape

1 Stop playback.



2 Press the ◀◀ key or ▶▶ key.

◀◀ : Fast tape winding in the ◀ direction.

▶▶ : Fast tape winding in the ▶ direction.



- Press the stop ■ key to stop fast tape winding.

### To pause playback (Deck B only)



- The ■ indicator lights.

### To stop playback

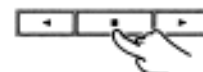

- Do not press the eject (▲) button until the tape has stopped completely.

### Usage of counter

Before starting recording (playback), press the **RESET A** or **RESET B** key to reset the counter to "0000", and write down the counter reading when the recording (playback) should be stopped in the middle of the tape, etc.; this will make it easy to locate the same position when you want to continue recording (playback) next time. It is also possible to use the Zero-stop function to return to the position where recording (playback) was started.



Deck A counter.



Display example.

### Zero-stop operation

#### Fast winding in the ▶ direction

Press simultaneously.



#### Fast winding in the ◀ direction

Press simultaneously.



- Tape is wound until counter reading near "0000" where it stops.

This function plays back the tapes in both decks A and B continuously and repeatedly.



 : Keys and control used in the operations described on this page.

## Relay playback

### 1 Load cassette tapes in both decks.

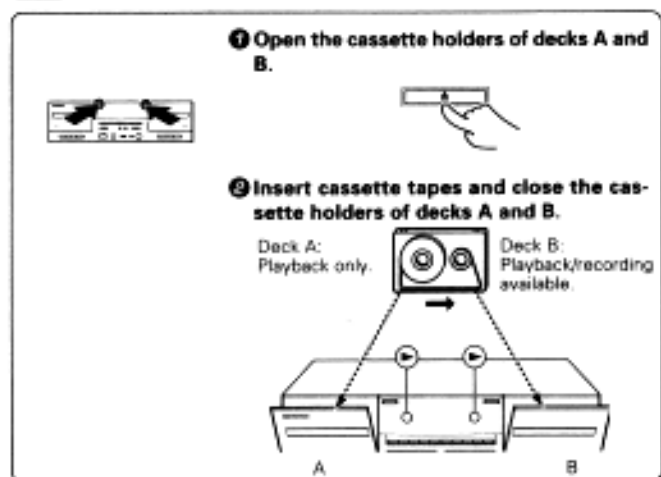

- Be sure to remove tape slack before insertion.
- Be sure to close the cassette holder securely by pushing it.

### 2 Determine the playback condition.

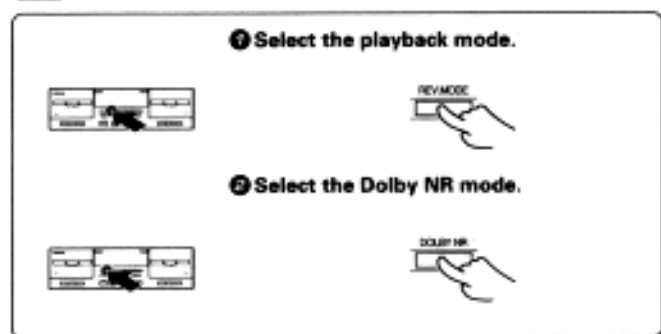

Each press switches the indication.

- ① "↔" : Relay playback of two sides of tapes in decks A and B is repeated.
- ② "↔" : Relay playback is not available with this setting.
- ③ "↔" : Relay playback of only one side of tapes in decks A and B is repeated.

Each press switches the indication.

- ① DOLBY NR "OFF" (extinguished): Dolby NR is not used.
  - ② DOLBY NR "B": Noise reduction of the ordinary type.
  - ③ DOLBY NR "C": Noise reduction with higher performance.
- Select the Dolby NR mode according to the tape recording status.

### 3 Start playback.

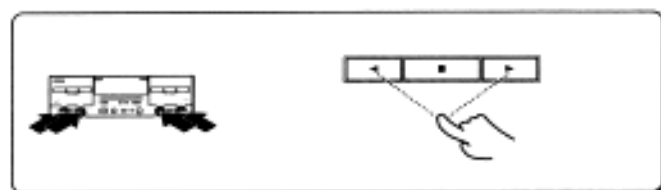

- Tapes are played in the directions indicated by their respective indicators on the display.
- The playback starts with the deck the play key of which is pressed.

### To Stop relay playback

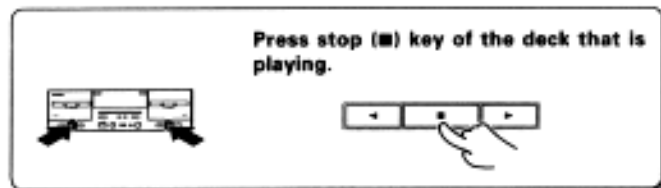



# Convenient music search (DPSS)

The DPSS (Direct Program Search System) enables the following convenient operations according to the instructions of the operation keys (these operation are however not available on both decks simultaneously). The DPSS functions are based on the detection of non-recorded spaces of 4 seconds or more between tunes.

- 1. Skip play** : By specifying a tune located several tunes beyond (or behind) the tune being played, skips tunes between the current tune and the selected tune and starts playback from the beginning of the selected tune. Up to 16 tunes can be skipped in Skip Search.
- 2. Single-tune repeated playback** : One single tune is played back repeatedly up to 16 times.

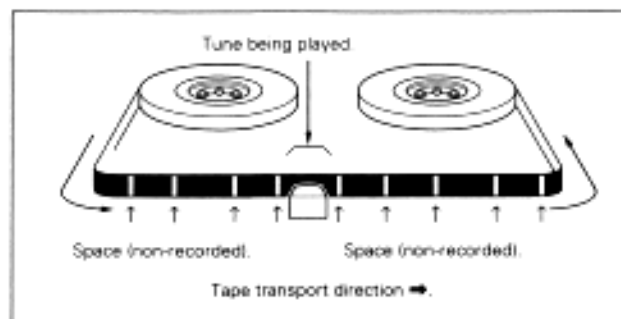

 : Keys and control used in the operations described on this page.

## Skip play operation

The example below shows the case in which the direction indicated by the tape transport direction indicator is  $\blacktriangleright$ . If the direction indicated by the tape direction indicator is  $\blacktriangleleft$ , always press the keys for the opposite directions to those shown in the illustrations below.

**To play a tune located immediately after the tune being played**



Press once during the playback.



**To play the tune being played from the beginning**



Press once during the playback.



**To play a tune located 4 tunes beyond**



Press 4 times during the playback.



**To play the tune located 4 tunes behind**



Press 5 times during the playback.



**DPSS will not function properly with the following types of tapes.**

- Tapes containing spaces of 4 seconds or more, such as conversations and speeches.
- Tape containing extremely low levels or non-recorded spaces in the middle of tunes, such as classical music.
- Tapes containing recording of large noise between tunes.
- Tapes containing spaces of less than 4 seconds between tunes.
- Tapes recorded with low recording level.
- Tapes recorded using Cross-fade recording.



## Single-tune repeated playback operation

- 1 Play the tune to be repeated.
- 2 Press the play key of the same direction as the current tape transport direction. When direction of tape direction indicator is ▶:



- Normal playback resumes after repeating the same tune for 16 times.
- Press the stop (■) key to stop playback and cancel this operation.

# How to record (Deck B only)

The cassette deck incorporates the Dolby HX Pro headroom extension function and auto-bias function to provide a recording with superior high-frequency characteristics. Since this unit is not designed for recording with metal (TYPE IV) tapes, do not use metal tapes for recording.

**Preparation** ① Make "Playback (recording) preparation".

② (Load a disc in the CD player)



Keys and control used in the operations described on this page.

## Normal recording

**1** Select the source to be recorded.

**2** Perform auto-bias adjustment. (The bias adjustment is applied to deck B.)

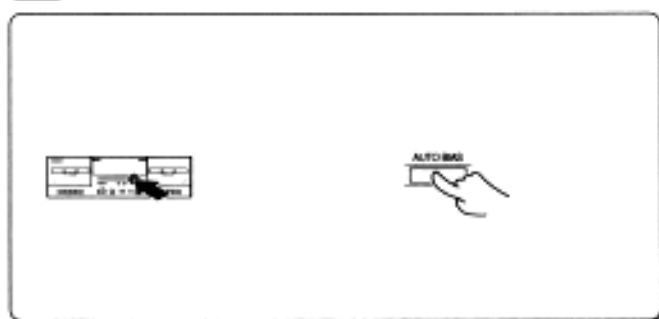

- Select by operating the input selector of the amplifier (optional).
- In case of recording a FM broadcast, refer to description of "How to use the MPX FILTER key".

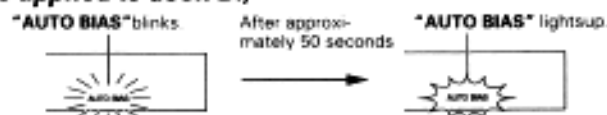

- The optimum bias is set in about 50 seconds, after which the deck enters the stop mode.
- For a fine adjustment after setting AUTO BIAS, refer to the description of "Bias level adjustment".
- To cancel the auto-bias adjustment operation in the middle, press the stop key.
- Recording is possible even when the auto-bias setting is omitted.
- If the amount of remaining tape is small, the auto-bias adjustment may be canceled in the middle and tape stopped at that position.
- The bias level is canceled when the eject key is pressed.

**3** Set the recording level.

① Play a music source.  
② Enter the record-pause mode.

③ Press the MODE key and select the "BAL." mode.

④ Adjust the recording balance.

Right sound decreases. Left sound decreases.

⑤ Press the MODE key and select the "LEVEL" mode.

⑥ Adjust the recording level.

Recording level decreases. Recording level increases.

⑦ Stop playing the source.

- While pressing the PAUSE key, press the REC/ARM key.

Each press of the MODE key changes the setting.

- ① "LEVEL" lights up: Recording level setting mode
- ② "BAL." lights up: Recording balance setting mode
- ③ "BIAS" lights up: Recording bias setting mode
- ④ "LEVEL", "BAL.", and "BIAS" go off: Counter display mode



- In counter, adjust the recording balance level so that the left and right displays are the same. You can also check with the (L) and (R) peak level indicators.

Each press of the MODE key changes the setting.

- ① "LEVEL" lights up: Recording level setting mode
- ② "BAL." lights up: Recording balance setting mode
- ③ "BIAS" lights up: Recording bias setting mode
- ④ "LEVEL", "BAL.", and "BIAS" go off: Counter display mode

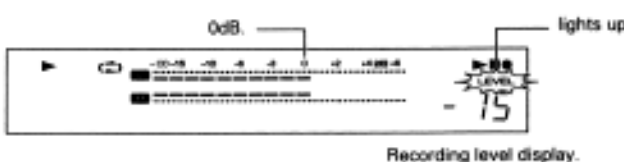

- Adjust the recording level so that the 0 dB of the peak level indicators sometimes lights up.



**4 Start recording.**

- ① Press the REC/ARM (●) key.



Press once.

- ② Play the music source from the beginning.

- Recording will start.
- The deck enters the stop mode automatically when the tape has been recorded till the end.

**Bias level adjustment**

The MODE key can be used to adjust the bias level.

- ① Press the MODE key and select the "BIAS" mode.



- ② Adjust the bias level.



The high frequency decreases.

The high frequency increases.

Each press of the MODE key changes the setting.

- ① "LEVEL" lights up: Recording level setting mode
- ② "BAL." lights up: Recording balance setting mode
- ③ "BIAS" lights up: Recording bias setting mode
- ④ "LEVEL", "BAL.", and "BIAS" go off: Counter display mode



- To adjust the bias level, play back the recorded sound and adjust to the suitable level. Repeat if necessary.
- The bias can be adjusted to a value of  $\pm 3$ .

**How to use the MPX FILTER key**

Use this function when recording a radio (FM) broadcasts.



Depending on the tuner, a recorded FM broadcast may produce a "beat" sound. In this case, press the MPX FILTER key before recording. To cancel, press the MPX FILTER key again.



**To pause recording temporarily****Pause**

- The || indicator lights.

**To resume recording****To stop recording**

- 1 Stop the tape transport.



- 2 Stop playing the source component.

**How to provide non-recorded blanks between programs****In stop mode**

Press successively twice.

**During recording**

Press once.



- After leaving a non-recorded blank of about 4 seconds, the deck enters the record-pause mode.

# Tape dubbing operation (Deck A ⇒ Deck B)

The dubbing refers to the copy of the recorded contents of a tape to another tape (tape in Deck A ⇒ tape in Deck B). Since this unit is not designed for recording with metal (TYPE IV) tapes, do not use metal tapes for recording.

## Preparation

- 1 Load the tape to be played in deck A and the tape to be recorded in deck B. — [REVERSE]
- 2 Set the tape transport directions of decks A and B to the same direction ( by pressing the play (▶) key then pressing the stop (■) key immediately after it ).
- 3 Make "Playback (recording) preparation".



■ : Keys and control used in the operations described on this page.

## Tape dubbing

### 1 Perform auto-bias adjustment. (The bias adjustment is applied to deck B.)

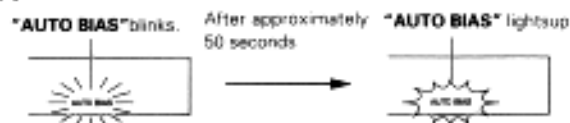

- The optimum bias is set in about 50 seconds, after which the deck enters the stop mode.
- Recording is possible even if the auto-bias adjustment operation is omitted.

For normal-speed dubbing.



For high-speed dubbing.



**Normal dubbing:**  
Dubbing at the normal speed.

"DUBBING NORMAL" lights up.



**High-speed dubbing:**  
Dubbing at about twice the normal speed.

"DUBBING HIGH" lights up.

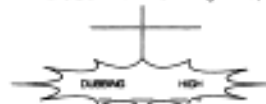

## To pause dubbing

For normal-speed dubbing.



For high-speed dubbing.



- Only deck B enters the record-pause mode after leaving a non-recorded space of about 4 seconds in case of normal-speed dubbing, or about 6 seconds in case of high-speed dubbing.
- To resume dubbing after pause, press the same **DUBBING** key as above (**NORMAL DUBBING** or **HIGH DUBBING**) again.

## To stop dubbing

Press the stop (■) key of Deck B.

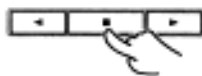

- Both decks A and B enter the stop mode.

1. The recording balance and recording level cannot be adjusted for dubbing.

2. The **DOLBY NR** is not active during dubbing.

The tape recorded by dubbing features the same NR system as the original tape in Deck A.

3. Noise from TV may interfere with dubbed sound if high-speed dubbing is executed near a TV set. To prevent this, install the system farther from the TV set.

4. If the original tape was recorded at a high level, the sound quality may be degraded, if high-speed dubbing is used. In such a case, use normal-speed dubbing.



# Convenient CD recording (Deck B only)

By connecting this unit with a KENWOOD "SL16", type amplifier (receiver) with a SYSTEM CONTROL jack and a KENWOOD CD player with a SYSTEM CONTROL jack using system control cords, recording on this unit and playback on the CD player can be started simultaneously.

Since this unit is not designed for recording with metal (TYPE IV) tapes, do not use metal tapes for recording.

## Preparation

- 1 Complete the connections referring to "System connections".
- 2 Make "Playback (recording) preparation".
- 3 (Load a disc in the CD player.)



■ : Keys and control used in the operations described on this page.

## CD synchro recording

### 1 Perform auto-bias adjustment.



- The optimum bias is set in about 50 seconds, after which the deck enters stop mode.
- For a fine adjustment after setting **AUTO BIAS**, refer to the description of "Bias level adjustment".
- To cancel the auto-bias adjustment operation in the middle, press the stop (■) key.
- Recording is possible even when the auto-bias setting is omitted.

### 2 Adjust the recording level.

#### 1 Play a CD.

Press the ▶/II key of the CD player.

#### 2 Set the record-pause mode.

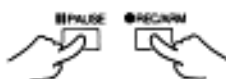

- While pressing the **PAUSE (II)** key, press the **REC/ARM (●)** key.

#### 3 Adjust the recording balance and recording level.

"How to record."



#### 4 Put the CD player in stop mode.

Press ■ key of the CD player.

### 3 Set the record-pause mode.

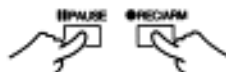

- While pressing the **PAUSE (II)** key, press the **REC/ARM (●)** key.

### 4 Start playing the CD.

Press the ▶/II key of the CD player.

- Synchro recording is not possible when tracks of more than one CD are programmed using a Carrousel type CD player.
- Recording starts at this moment.
- When the CD player has completed playback, the cassette deck stops recording and enters the stop mode.

To pause : Press the ▶/II key of the CD player.  
To restart recording : Press the ▶/II key of the CD player.  
To stop : Press the ■ key of the CD player.

- If the stop (■) key of the cassette deck is pressed, the cassette deck enters the stop mode but the CD player does not stop.

When connected with a KENWOOD amplifier, CD player provided with "SL16" marking through the system control cord, this unit allows to use the CCRS, which starts recording automatically after setting the optimum recording level for the CD and tape to be used in recording.

Since this unit is not designed for recording with metal (TYPE IV) tapes, do not use metal tapes for recording.

### Preparation

- 1 Complete the connections referring to "System connections".
- 2 (Set the input selector of the amplifier to CD.)
- 3 (Load a disc in the CD player.)  
(Edit tracks as required on the CD player.)



■ : Keys and control used in the operations described on this page.

## Recording of CD playback (CCRS) (Deck B only)

**1** Insert a tape in deck B.

**2** Determine the recording condition.

1 Select the recording mode.

2 Select the Dolby NR mode.

• For the tape direction setting, see the description below "Select the tape transport direction".

Each press switches the indication.

- 1 "↔" : Double-side recording.
- 2 "↔" : (Tape also stops after having recorded both sides.)
- 3 "→" : One-way recording.

Each press switches the indication.

- 1 DOLBY NR "OFF" (extinguished): Dolby NR is not used.
- 2 DOLBY NR "B": Noise reduction of the ordinary type.
- 3 DOLBY NR "C": Noise reduction with higher performance.

• Select the Dolby NR mode according to the tape recording status.

**3** Press the CCRS key.

• Program-edit recording is not possible when tracks of more than one CD are programmed using a Carrousel type CD player.

• When performing CCRS recording with a CD player which can be loaded multiple compact discs, set the CD player to TRACK mode, press the disc selector key and press the CCRS key of the cassette deck.

• The CCRS indicator blinks, and actual recording starts in about 20 to 200 seconds (after creating a non-recorded blank of about 8 seconds).

### How to cancel CCRS

**During recording level setting:**

Press the Stop key of the CD player or the stop key of the cassette deck.

**During CCRS recording:**

Press the Stop key of the CD player, then press the OPEN / CLOSE key of the CD player.

**After completion of CCRS recording:**

Press the OPEN / CLOSE key of the CD player.

• After recording, the cassette deck and CD player enter the stop mode automatically.

• After completion of CCRS recording, be sure to cancel the CCRS and ensure that the CCRS indicator has gone off.

1. If the CCRS key is pressed during CD playback, playback stops and CCRS operation begins.
2. If the remaining amount of tape is small, CCRS may not function correctly or CCRS operation may be canceled in mid-operation.
3. Once the CCRS recording level has been set, the recording balance and recording level cannot be adjusted while the CCRS operation is being carried out.
4. The CCRS function sets the peak level for the entire CD in approx. 20~200 seconds. On very rare occasions, however, the function may not be able to set the optimum recording level. If this occurs, carry out recording manually referring to the "Normal recording" section.
5. The CCRS recording level setting is canceled when the open/close key of the CD player is pressed or when the power is switched OFF.
6. With CD players equipped with the EDIT function, it is possible to make recordings in which the last songs on sides A and B are not cut off in the middle and in which the recording capacity of the tape is used to the fullest extent. (Set the REV.MODE key of the deck to "↔".)



# Timer operations

This unit incorporates a built-in timer standby function. By using an audio timer optionally available in the market, wake-up playback and unattended recording of tape can be started at any time of the day. Connect the power cords of the components directly or indirectly to the timer so that their powers can be turned on via the timer. The timer setup operation varies depending on the timer. Also read carefully the instruction manual of your audio timer.

## Preparation

- 1 Set the power switches of the components to ON.
- 2 Set the input selector of the amplifier to TAPE.
- 3 Make "Playback (recording) preparation".

(If relay playback is required, insert tapes in both decks A and B.)

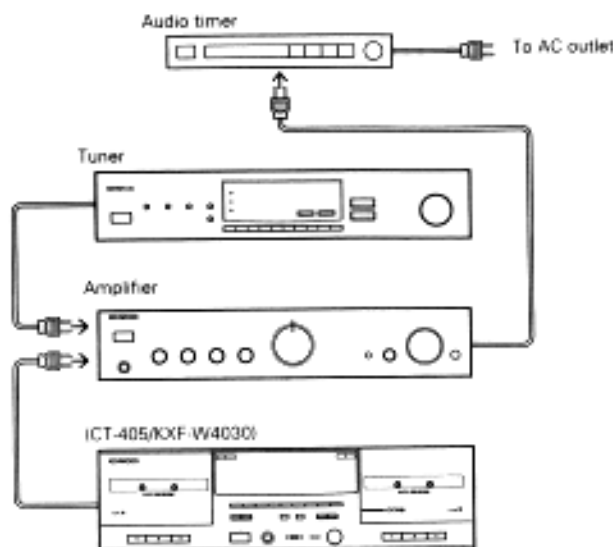

## Timer playback of tape

### 1 Start playback.

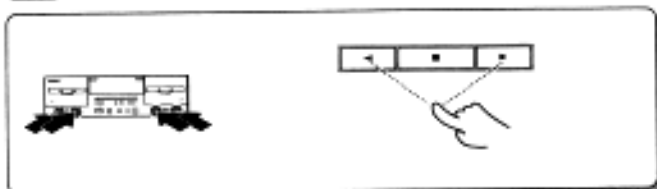

### 2 Adjust the volume of the amplifier.

### 3 Rewind the tape(s) to the start position.

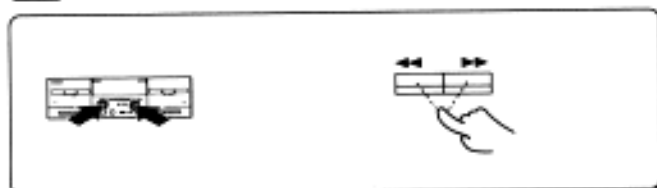

### 4 Set the TIMER switch to PLAY.

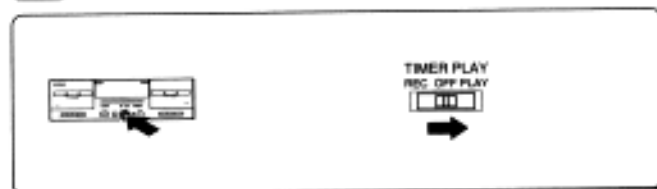

### 5 Set the timer.

- Set the timer so that the tape starts at the desired time of the day.
- When the set time comes, tape playback starts automatically.
- Read carefully the instruction manual of your audio timer.



1. When connecting the KENWOOD equipment (amplifier, CD player) and the system, remove the disc from the CD player.
2. If relay playback is required, set to "A" or "B".
3. If tapes are inserted in both decks A and B, timer playback starts with deck B.
4. Switch on the power to the cassette deck. (The timer will not operate if it is switched off.)

**Preparation**

- 1 Set the power switches of the components to ON.
- 2 Set the input selector of the amplifier to TUNER.
- 3 Receive the desired radio station with the tuner.
- 4 Make "Playback (recording) preparation".
- 5 (Remove the disc from the CD player.)



 : Keys and control used in the operations described on this page.

**Timer recording of tuner broadcast (Deck B only)**

- 1 Press the **MPX FILTER** key to ON. (when recording FM broadcasts only)



"MPX" lights up.



- Refer to the "How to use the MPX FILTER key".
- To cancel, press the **MPX FILTER** key again.

- 2 Adjust the recording level.



- 1 Set the record-pause mode.



- 2 Adjust the recording balance and recording level.

- While pressing the **PAUSE (|||)** key, press the **REC/ARM (●)** key.
- Refer to the "How to record".

- 3 Set the amplifier volume to the minimum position.

- 4 Set the **TIMER** switch to **REC**.



- 5 Set the timer.

- Set the desired time when the recording is to be started.
- When the set time comes, the powers of the related components are turned ON and recording starts.
- Recording stops when the end of side to be recorded is reached.
- Read carefully the instruction manual of your audio timer.



1. To ensure that the cassette deck's automatic shut off switch operates before the power is shut off, set the timer so that it operates for a little longer than the playing time of the tape.
2. Switch on the power to the cassette deck. (The timer will not operate if it is switched off.)

What appears to be a malfunction may not always be serious. If your unit should not perform as expected, consult the table below to see if the problem can be corrected before seeking help from your dealer or service representative.

## Operation to reset

The microcomputer may fall into malfunction (impossibility to operate, erroneous display, etc.) when the power cord is unplugged while this unit is ON or due to an external factor. In this case, execute the following method to reset the microcomputer and return it to normal condition.

Turn the power switch on and off again while pressing the stop (■)key on deck B.

- Please note that resetting microcomputer clears contents stored in and returns it to the condition when it left the factory.

Symptom	Cause	Remedy
Sounds is not produced when the Play key is pressed.	<ul style="list-style-type: none"> <li>● The connection cords are connected improperly.</li> <li>● The head is dirty.</li> <li>● Tape is irregularly wound and hard to take up.</li> <li>● A non-recorded tape is being played.</li> </ul>	<ul style="list-style-type: none"> <li>● Connect the cords properly referring to "System connections" - [3]</li> <li>● Clean the head referring to "Cleaning the head section" - [4]</li> <li>● Replace the tape</li> <li>● Play a recorded tape.</li> </ul>
The deck does not work when an operation key is pressed.	<ul style="list-style-type: none"> <li>● The cassette holder is not closed completely.</li> <li>● The operation key was pressed immediately after closing the cassette holder.</li> <li>● An operation key is pressed in less than 3 seconds after this unit is turned ON.</li> <li>● Tape is not inserted.</li> <li>● Tape is irregularly wound and hard to take up.</li> <li>● Tape has been fully wound to reel.</li> </ul>	<ul style="list-style-type: none"> <li>● Close the cassette holder completely.</li> <li>● Press the desired operation key in a few seconds after closing the cassette holder.</li> <li>● Press the desired operation key in more than 3 seconds after turning the power on.</li> <li>● Insert a tape.</li> <li>● Replace the tape.</li> <li>● Change the tape transport direction or insert the tape inversely.</li> </ul>
DPSS malfunctions.	<ul style="list-style-type: none"> <li>● The tape is not suitable for DPSS operation, for example the spaces between tunes are too short.</li> </ul>	<ul style="list-style-type: none"> <li>● Read "Convenient music search (DPSS)" - [14]</li> </ul>
CCRS does not work.	<ul style="list-style-type: none"> <li>● A recordable tape is not inserted in deck B.</li> <li>● A disc is not placed in the CD player.</li> <li>● The system control cord may be disconnected.</li> <li>● The disc is dirty.</li> </ul>	<ul style="list-style-type: none"> <li>● Insert a recordable tape in deck B and press the CCRS key.</li> <li>● Place a disc in the CD player and press the CCRS key.</li> <li>● Connect the system control cord securely.</li> <li>● Clean the disc, place it in the CD player, and press the CCRS key.</li> </ul>
The dubbing on Deck A and Deck B ends at different timing.	<ul style="list-style-type: none"> <li>● This is due to the difference in tape length or to the characteristics of the cassette deck mechanisms.</li> </ul>	<ul style="list-style-type: none"> <li>● A small time difference is not regarded as a failure.</li> </ul>
The cassette holder does not open when the eject (▲)key is pressed.	<ul style="list-style-type: none"> <li>● The key is pressed during recording or playback.</li> </ul>	<ul style="list-style-type: none"> <li>● Press in the stop mode.</li> </ul>
Sound is hoarse, or high frequencies are not audible.	<ul style="list-style-type: none"> <li>● The head is dirty.</li> <li>● The tape is stretched or wrinkled.</li> </ul>	<ul style="list-style-type: none"> <li>● Clean the head referring to "Cleaning the head section" - [4]</li> <li>● Replace the tape.</li> </ul>
Sound is distorted.	<ul style="list-style-type: none"> <li>● The recording level was too high.</li> <li>● A tape recorded with distorted sound is being played.</li> </ul>	<ul style="list-style-type: none"> <li>● Adjust the recording level referring to "How to record" - [16]</li> <li>● Replace the tape.</li> </ul>



Symptom	Cause	Remedy
Recording is not initiated when the REC/ARM (●) key is pressed.	<ul style="list-style-type: none"> <li>● The protection tab on the cassette has been broken.</li> <li>● The cassette holder is not closed completely.</li> <li>● The recording level is set to the minimum position.</li> <li>● The TAPE input selector is selected on the amplifier.</li> <li>● Tape has been fully wound to a reel.</li> </ul>	<ul style="list-style-type: none"> <li>● Use a cassette with unbroken tab or close the hole.</li> <li>● Close the cassette holder completely.</li> <li>● Adjust the recording level referring to "How to record" → (18)</li> <li>● Press the input selector key of the source to be recorded.</li> <li>● Change the tape transport direction of deck or insert the tape inversely.</li> </ul>
Noise level is high.	<ul style="list-style-type: none"> <li>● The head is magnetized.</li> <li>● External noise is induced.</li> <li>● The system assembly position is wrong.</li> <li>● The recording level was too low.</li> <li>● A tape recorded with Dolby NR ON is being played with Dolby NR OFF.</li> </ul>	<ul style="list-style-type: none"> <li>● Demagnetize the head referring to "Cleaning the head section" → (2)</li> <li>● Install the system apart from other electrical appliances and TV set.</li> <li>● Change the arrangement or the position of the equipment.</li> <li>● Adjust the recording level referring to "How to record" → (18)</li> <li>● Set the DOLBY NR key to B or C.</li> </ul>
Sound is vibrating.	<ul style="list-style-type: none"> <li>● The capstans or pinch rollers are dirty.</li> <li>● Tape is irregularly wound.</li> </ul>	<ul style="list-style-type: none"> <li>● Clean the capstans and pinch rollers.</li> <li>● Wind the tape regularly by fast forwarding, rewinding or playing it fully from one reel to another.</li> </ul>
Playback or recording starts immediately when the power is switched ON.	<ul style="list-style-type: none"> <li>● The TIMER switch is set to PLAY or REC.</li> </ul>	<ul style="list-style-type: none"> <li>● Set the TIMER switch to OFF unless timer playback or timer recording is required</li> </ul>



With some tapes, a squeaky noise is produced when the tape is stopped automatically. This is due to the tape protection function, and not a malfunction.

## Dolby noise reduction system - [13]

### Dolby noise reduction system

The Dolby noise reduction system was developed to reduce the tape hiss noise generated during playback.

The optimum effect of the Dolby NR system is obtained when the same type NR system is used for both recording and playback. If a different type NR system is used, playback is not performed correctly. Make sure that the same type noise reduction system is used for both recording and playback.

#### Dolby B NR

The most popular noise reduction system used in home audio components. Usually, Dolby NR system corresponds to B NR.

#### Dolby C NR

Dolby C NR offers improved noise reduction performance over that of the Dolby B NR. It features a superior noise reduction effect, use Dolby C NR to record or playback with this unit.

It is recommended that tapes recorded with the Dolby NR system be marked "B" or "C", so that they can easily be distinguished.

## DPSS (Direct Program Search System) - [14]

The DPSS detects non-recorded blanks of 4 seconds or more between music and enables the following four types of simple playback operations according to the instructions given by pressing operation keys. (It is not possible to perform DPSS operations simultaneously on the two decks.)

1. Skip play : By specifying a tune located several tunes beyond (or behind) the tune being played, skips tunes between the current tune and the selected tune and starts playback from the beginning of the selected tune. Up to 16 tunes can be skipped in Skip Search.
2. Single-tune repeated playback : One single tune is played back repeatedly up to 16 times.

## Recording with Dolby HX Pro - [16]

### What is Dolby HX Pro?

In ordinary recording using high-frequency biasing, the high-frequency bias current, which should be constant, is increased with some recording sources due to the high-frequency component contained in the music, etc. This increase affects the recording characteristics with distorted high frequencies and degraded dynamic range and frequency response.

The Dolby HX Pro circuit detects the high-frequency component contained in the music source being recorded, and reduces excessive bias current to make it constant. As a result, the recording characteristics of high frequencies are drastically improved, and the improved high-frequency reproduction can also be enjoyed even when the tape is played on tape decks which are not equipped with circuit.

## Auto-bias function - [18]

The auto-bias function automatically adjusts the tape's bias value to ensure optimum recording performance with each and every tape.

## CCRS (Computer-controlled CD Recording System) - [21]

When connected with a KENWOOD amplifier, CD player provided with "SL16" marking through the system control cord, this unit allows to use the CCRS, which starts recording automatically after setting the optimum recording level for the CD and tape to be used in recording.

1. The CD starts to be played, and the peak value is sampled from the levels of the signals on the CD.
2. The optimum recording level for the specific CD is determined and set based on the peak value sampled.
3. The recording preparation steps above take about 20~200 seconds, after which the actual recording starts.
4. After recording (when the CD player is stopped or when the tape has run out), both the cassette deck and CD player stop.

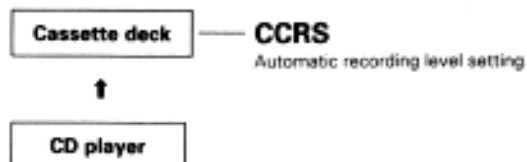

# Specifications

Track System .....	4 track, 2 channel stereo	
Recording System .....	AC bias (Frequency: 105 kHz)	
Heads .....	A DECK	
	Playback head .....	1
	B DECK	
	Playback/recording heads .....	1
	Erasing head .....	1
Motors .....	A DECK .....	DC motor × 1
	B DECK .....	DC motor × 1
Wow and Flutter .....	±0.17 % (IEC)	
	±0.28 % (DIN)	
	0.1 % (W.R.M.S)	
Fast Winding Time .....	Approx. 110 seconds (C-60 tape)	
Frequency Response		
TYPE I tape .....	30 Hz to 18,000 Hz, ±3 dB	
TYPE II tape .....	30 Hz to 19,000 Hz, ±3 dB	
Signal to Noise Ratio		
Dolby NR OFF .....	56 dB	
(IEC, 250 nWb/m, TYPE II tape)		
Dolby NR OFF .....	59 dB	
Dolby B NR ON .....	68 dB	
Dolby C NR ON .....	75 dB	
(3rd, H.D., 3 %, TYPE II tape)		

Harmonic Distortion .....	Less than 1.2 %
(at 315 Hz, 3rd H.D., 250 nWb/m, TYPE II tape)	
Input sensitivity/Impedance	
LINE IN .....	122.8 mV/47 kΩ
Output Level/Impedance	
LINE OUT .....	775 mV/1.0 kΩ
Headphones .....	0.5 mW/32 Ω
[General]	
Power Consumption .....	20 W
Dimensions .....	W: 440 mm (15-3/4")
	H: 132 mm (5-3/16")
	D: 380 mm (14-15/16")
Weight (Net) .....	5.3 kg (11.7 lb)



1. KENWOOD follows a policy of continuous advancements in development. For this reason specifications may be changed without notice.
2. The full performance may not be exhibited in an extremely cold location (under a water-freezing temperature).